



Technical Evaluation Report

TO ASSIST WITH CODE COMPLIANCE

**FastenMaster ThruLOK™
Pole Barn Header Connection**

TER No. 1308-11

**OMG, Inc.
d/b/a/ FastenMaster**

153 Bowles Road
Agawam, Massachusetts 01001
413-789-0252
fastenmaster.com
mguthrie@olyfast.com

**Issue Date: September 13, 2013
Updated: August 2, 2016
Subject to Renewal: October 1, 2017**

DIVISION: 06 00 00 – WOOD, PLASTICS, AND COMPOSITES
Section: 06 05 23 – Wood, Plastic, and Composite Fastenings
Section: 06 11 00 – Wood Framing

1. Product Evaluated:

- 1.1. ThruLOK™ Screw Bolt Fastening System
- 1.2. For the most recent version of this Technical Evaluation Report (TER), visit drjengineering.org. For more detailed state professional engineering and code compliance legal requirements and references, visit drjengineering.org/statelaw. DrJ is fully compliant with all state professional engineering and code compliance laws.

DrJ is a Professional Engineering Approved Source

 **Learn more about DrJ's Accreditation**

- DrJ is an ISO/IEC 17065 accredited product certification body through ANSI Accreditation Services.
- DrJ provides certified evaluations that are signed and sealed by a P.E.
- DrJ's work is backed up by professional liability insurance.
- DrJ is fully compliant with IBC Section 1703.



Technical Evaluation Report (TER)

2. Applicable Codes and Standards:¹

- 2.1. 2009, 2012 and 2015 International Building Code (IBC)
- 2.2. 2009, 2012 and 2015 International Residential Code (IRC)
- 2.3. ASTM A510 – Standard Specification for General Requirements for Wire Rods and Coarse Round Wire, Carbon Steel, and Alloy Steel
- 2.4. ASTM B695 – Standard Specification for Coatings of Zinc Mechanically Deposited on Iron and Steel
- 2.5. ASTM F1575 – Standard Test Method for Determining Bending Yield Moment of Nails
- 2.6. National Design Specification for Wood Construction (NDS)

3. Performance Evaluation:

3.1. The ThruLOK™ Screw Bolt Fastening System was evaluated to determine its ability to provide code complying attachment of horizontal roof headers to vertical columns (posts) to resist roof to header to column gravity loads and the associated load paths.

3.1.1. The evaluation includes both single header and double header configurations (see [Figure 2](#) and [Figure 3](#)).

3.2. Use of the ThruLOK™ Screw Bolt Fastening System for other connections is outside the scope of this technical evaluation report (TER).

3.3. Any code compliance issues not specifically addressed in this section are outside the scope of this evaluation.

4. Product Description and Materials:

4.1. ThruLOK™ Screw Bolt Fastening System, shown in [Figure 1](#).

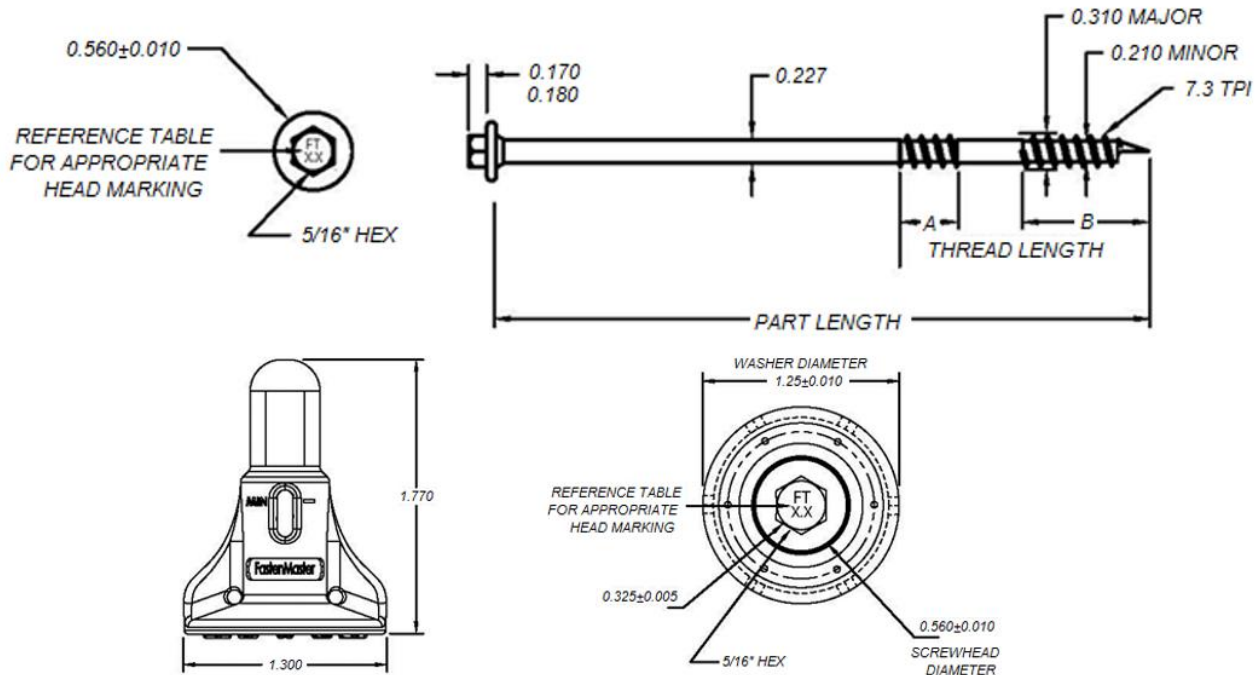

Figure 1: ThruLOK™ Screw Bolt Fastening System

4.1.1. The FastenMaster ThruLOK™ series fasteners listed in [Table 1](#) were evaluated.

¹ Unless otherwise noted, all references in this code compliant technical evaluation report (TER) are from the 2015 version of the codes and the standards referenced therein, including, but not limited to, ASCE 7, SDPWS and WFCM. This product also complies with the 2000-2009 and 2012 versions of the IBC and IRC and the standards referenced therein. As required by law, where this TER is not approved, the building official shall respond in writing, stating the reasons this TER was not approved. For variations in state and local codes, if any, see [Section 8](#).

Technical Evaluation Report (TER)

Fastener Name	Fastener Designation	Head Marking	Length ¹ (in.)	Length of Thread ² (in.)		Unthreaded Shank Diameter (in.)	Minor Thread (Root) Diameter (in.)	Allowable Bending Yield (psi) ³
				A	B			
ThruLOK™	THR912	FT9.5	9.5	0.56	1.2	0.227	0.210	218,400
ThruLOK™	THR008	FT8.0	8.0	0.56	1.2	0.227	0.210	218,400

1. Measured from the underside of the head to the point of the tip.
2. The thread lengths given for the ThruLOK™ are for zones A and B, as depicted in [Figure 1](#).
3. Determined in accordance with methods specified in *ASTM F1575*, based on minor thread diameter using a 5% offset of the load displacement curves developed from bending tests.
4. Fastener designs were evaluated under *NDS* wet service (also known as wet-use) conditions to account for the effects of higher header and/or column moisture content.
5. Lumber used shall be either treated Southern Pine, treated Hem-Fir or treated Douglas Fir.

Table 1: Fastener Designation for the ThruLOK™ Fasteners Evaluated

- 4.1.2. ThruLOK™ fastener heads have a $\frac{5}{16}$ " hex drive.
- 4.1.3. Allowable bending yield and critical dimensions are found in [Table 1](#).
- 4.1.4. ThruLOK™ fasteners have a proprietary cutting point and are supplied with a ThruLOK™ washer and nut.
- 4.1.5. ThruLOK™ fasteners are manufactured with carbon steel grade 1022 or 10B21 wire conforming to *ASTM A510* with a minimum ultimate tensile strength of 60 ksi.
- 4.1.6. ThruLOK™ fasteners are coated with mechanically applied zinc in accordance with *ASTM B695*, Class 55 as specified in [IRC Section R317.3.1](#).

5. Applications:

5.1. Structural Applications

5.1.1. Where the application exceeds the limitations set forth herein, design shall be permitted in accordance with accepted engineering procedures, experience, and good technical judgment.

5.2. [Figure 2](#) and [Table 2](#) illustrates the number of ThruLOK™ fasteners required to resist single shear of one header on one side of one column for various loading conditions.

5.2.1. [Table 2](#) shows the number of ThruLOK™ fasteners needed for various snow loading conditions.

5.2.2. For the header configuration shown in [Figure 2](#), it is assumed that the interior header will receive 75% of the load and the exterior header will receive 25% of the load.

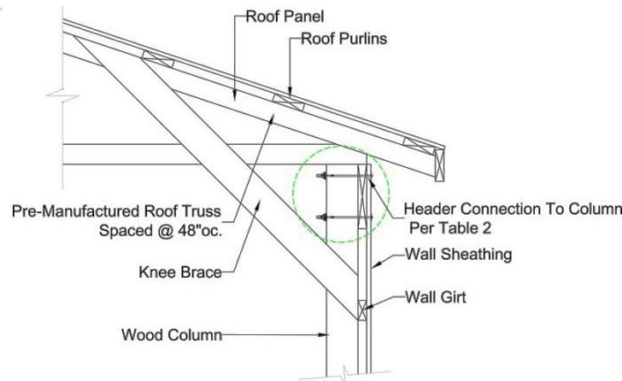

Figure 2: ThruLOK™ Screw Bolt Fastening System – Roof to Header Detail

Technical Evaluation Report (TER)

Single Shear – Truss Bearing on One Header to One Column						
Number of 8" ThruLOK™ Fasteners / Header						
Building Width Including 1' Overhang Each End (ft.)	Species (Pressure Treated)	Truss Spacing (ft.)	Column Spacing (ft.)	Loading (Snow + TC Dead + BC Dead) PSF		
				20+10+5 = 35	30+10+5 = 45	40+10+5 = 55
24	Hem-Fir	4	8	4	6	6
	Douglas-Fir			4	4	6
	Mixed Southern Yellow Pine			4	4	6
28	Hem-Fir	4	8	6	6	8
	Douglas-Fir			4	6	6
	Mixed Southern Yellow Pine			4	6	6
32	Hem-Fir	4	8	6	8	8
	Douglas-Fir			6	6	8
	Mixed Southern Yellow Pine			4	6	6
36	Hem-Fir	4	8	6	8	–
	Douglas-Fir			6	6	8
	Mixed Southern Yellow Pine			6	6	8
40	Hem-Fir	4	8	6	8	–
	Douglas-Fir			6	8	–
	Mixed Southern Yellow Pine			6	6	8
44	Hem-Fir	4	8	8	–	–
	Douglas-Fir			6	8	–
	Mixed Southern Yellow Pine			6	8	–
48	Hem-Fir	4	8	8	–	–
	Douglas-Fir			8	8	–
	Mixed Southern Yellow Pine			6	8	–
52	Hem-Fir	4	8	8	–	–
	Douglas-Fir			8	–	–
	Mixed Southern Yellow Pine			8	8	–

1. Fastener designs were evaluated under *NDS* wet service (also known as wet use) conditions to account for the effects of higher header and/or column moisture content.
 2. Lumber used shall be either treated Southern Pine, treated Hem-Fir or treated Douglas Fir.
 3. Connection design assumes that the header supports one truss located at midspan of the header. Trusses located at the columns shall be supported by bearing on the column and shall not apply loads to the header.
 4. Design of all wood members (e.g., columns/posts, headers, trusses, girts, knee braces, etc.) and connections not shown are by others.
 5. See [Section 5.3](#) for information on minimum required edge and end distances.

Table 2: Single Shear – One Header to One Column

- 5.3.** [Figure 3](#) and [Table 3](#) show the number of ThruLOK™ fasteners required to resist the shear of one header on one side of a single column and another header on the opposite side of the column, where both headers are connected to the column with ThruLOK™ fasteners.
- 5.3.1.** [Table 3](#) shows the number of ThruLOK™ fasteners needed for various snow loading conditions.
- 5.3.2.** For the header configuration shown in [Figure 3](#), it is assumed that the interior header will receive 75% of the load and the exterior header will receive 25% of the load.

Technical Evaluation Report (TER)

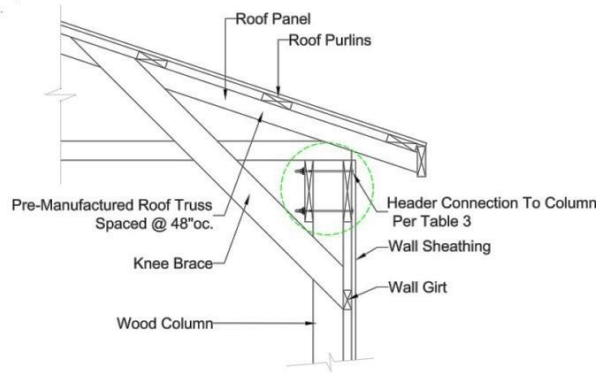

Figure 3: ThruLOK™ Screw Bolt Fastening System – Roof to Header Detail

Two-Beam Shear – Truss Bearing on Two Headers Connected to One Column						
Number of 9½" ThruLOK™ Fasteners / Header						
Building Width Including 1' Overhang Each End (ft.)	Species (Pressure Treated)	Truss Spacing (ft.)	Column Spacing (ft.)	Loading (Snow + TC Dead + BC Dead) PSF		
				20+10+5 = 35	30+10+5 = 45	40+10+5 = 55
24	Hem-Fir	4	8	4	4	6
	Douglas-Fir			4	4	4
	Mixed Southern Yellow Pine			4	4	4
28	Hem-Fir	4	8	4	6	6
	Douglas-Fir			4	4	6
	Mixed Southern Yellow Pine			4	4	4
32	Hem-Fir	4	8	4	6	6
	Douglas-Fir			4	4	6
	Mixed Southern Yellow Pine			4	4	6
36	Hem-Fir	4	8	6	6	8
	Douglas-Fir			4	6	6
	Mixed Southern Yellow Pine			4	6	6
40	Hem-Fir	4	8	6	6	8
	Douglas-Fir			4	6	8
	Mixed Southern Yellow Pine			4	6	6
44	Hem-Fir	4	8	6	8	8
	Douglas-Fir			6	6	8
	Mixed Southern Yellow Pine			4	6	8
48	Hem-Fir	4	8	6	8	–
	Douglas-Fir			6	6	8
	Mixed Southern Yellow Pine			6	6	8
52	Hem-Fir	4	8	6	8	–
	Douglas-Fir			6	8	8
	Mixed Southern Yellow Pine			6	6	8

1. Fastener designs were evaluated under *NDS* wet service (also known as wet use) conditions to account for the effects of higher header and/or column moisture content.
2. Lumber used shall be either treated Southern Pine, treated Hem-Fir or treated Douglas Fir.
3. Connection design assumes that the header supports one truss located at midspan of the header. Trusses located at the columns shall be supported by bearing on the column and shall not apply loads to the header.
4. See [Section 5.3](#) for information on minimum required edge and end distances.
5. Design of all wood members (e.g., columns/posts, headers, trusses, girts, etc.) and connections not shown are by others.

Table 3: Double Shear – Two Headers to One Column

Technical Evaluation Report (TER)

5.4. [Figure 4](#) and [Table 4](#) provide the required edge and end distances for these applications.

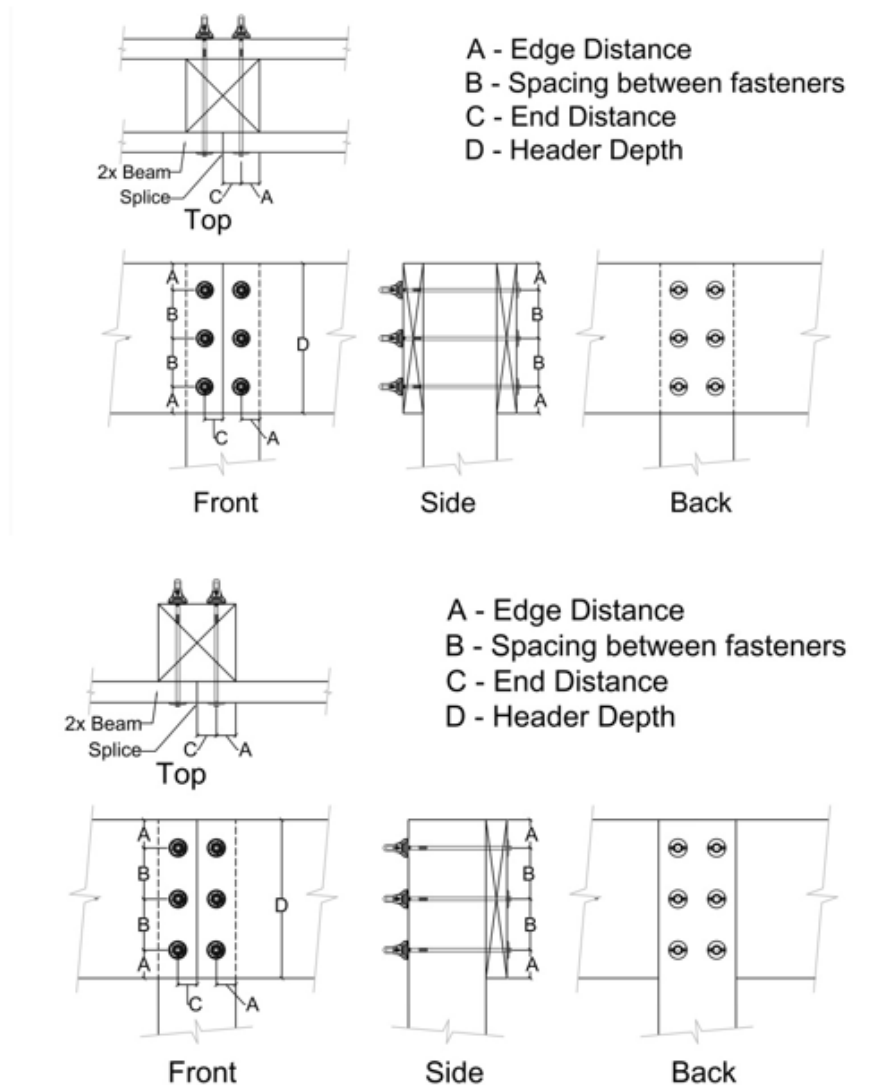

Figure 4: ThruLOK™ Screw Bolt Fastening System – Edge, End & Spacing Requirements

Fastener	Beam Size	Number of Fasteners	Header Member		Column Member		Fastener Spacing (in.) Between Rows
			Min. Edge Distance (in.)	Min. End Distance (in.)	Min. Edge Distance (in.)	Min. End Distance (in.)	
8" & 9½" ThruLOK™	2x8	4	2	1	Greater of 1" or ½ spacing between rows	2	3¼
		6					1⅝
	2x10	4	2	1	Greater of 1" or ½ spacing between rows	2	5¼
		6					2⅝
		8					1¾
	2x12	4	2	1	Greater of 1" or ½ spacing between rows	2	5⅝
		6					3⅝
		8					2½

1. Fastener designs were evaluated under *NDS* wet service (also known as wet-use) conditions to account for the effects of higher header and/or column moisture content.
 2. Lumber used shall be either treated Southern Pine, treated Hem-Fir or treated Douglas Fir.
 3. Design of all wood members (e.g., columns/posts, headers, trusses, girts, etc.) by others.

Table 4: Fastener Edge & End Distance and Spacing for the ThruLOK™ Fasteners Evaluated in this TER

Technical Evaluation Report (TER)

6. Installation:

6.1. General

- 6.1.1. The following installation instructions provide the general method of installing the FastenMaster ThruLOK™ Screw Bolt Fastening System for use with the specific applications as described in [Section 5](#).
- 6.1.2. Place the ThruLOK™ washer on the ThruLOK™ screw with the teeth of the washer facing away from the head of the fastener (toward the threads of the fastener).
- 6.1.3. Using a high-torque, ½" variable-speed drill (18V if cordless) with a 5/16" hex-head driver bit, drive the ThruLOK™ through the framing until the washer and hex head are just above the wood surface (approximately ¼"), and the point of the screw protrudes out of the other side of the connection.
- 6.1.4. Thread the ThruLOK™ nut onto the point of the fastener and hand tighten the nut until it is flush with the wood.
- 6.1.5. Tighten the screw with the drill-driver.
- 6.1.6. The point of the fastener must engage in the ThruLOK™ nut to the "MIN" line or beyond (see [Figure 1](#)).

Installation procedure for when a single 2x header is installed at exterior of column.

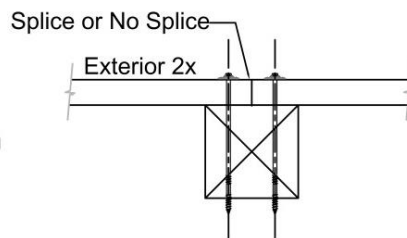

Step 1. Install ThruLok's from exterior 2x header side to ensure end and edge distances are maintained.

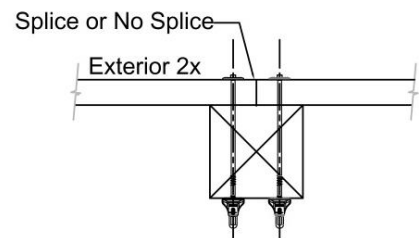

Step 2. Install nut on interior face and tighten

Installation procedure for when a header splice falls on exterior side of the column.

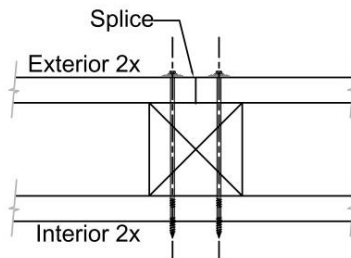

Step 1. Install ThruLok's from splice side (exterior 2x header side) to ensure end and edge distances are maintained.

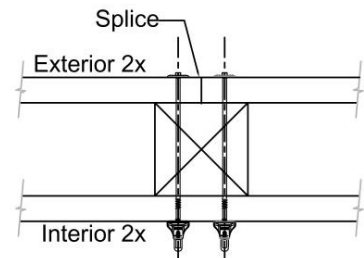

Step 2. Install nut on interior face and tighten

Figure 5a: Installation of Header with Splice on Exterior Side of Column

Technical Evaluation Report (TER)

Installation procedure for when a header splice falls on interior side of the column.

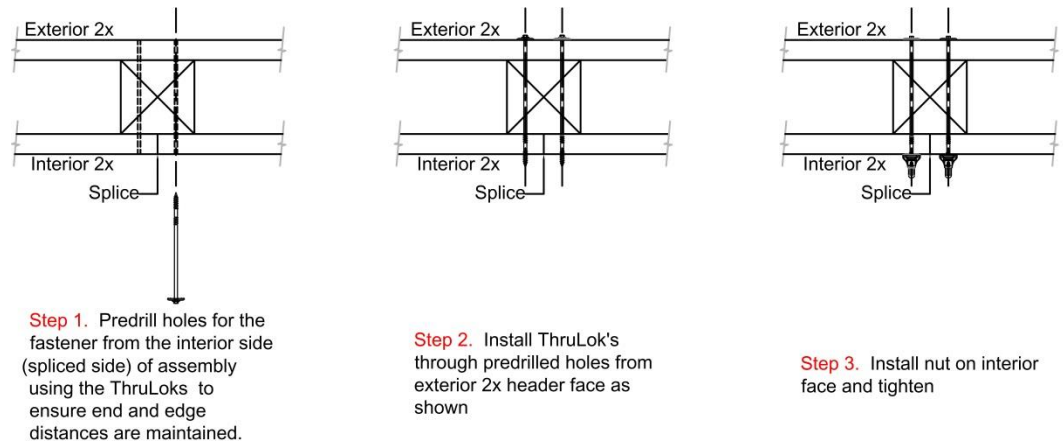

Figure 5b: Installation of Header with Splice on Interior Side of Column

6.1.7. A copy of the manufacturer's published installation instructions shall be available at all times on the jobsite during installation.

6.2. Installation shall comply with the manufacturer's installation instructions and this TER. In the event of a conflict between the manufacturer's installation instructions and this TER, the more restrictive shall govern.

7. Test and Engineering Substantiating Data:

7.1. Test reports and data supporting the ThruLOK™ Screw Bolt Fastening System structural properties and application specifications include:

7.1.1. University Of Montana Wood Science Laboratory, *Determination of Lateral Withdrawal Strength of OMG ThruLOK® Fasteners Based on Specific Gravity and Grain Orientation of ACQ Treated Lumber*, UMWSL Project # 2010101-1.

7.1.2. Engineering analysis and calculations by Qualtim, Inc.

- 7.2.** The product(s) evaluated by this TER falls within the scope of one or more of the model, state or local building codes for building construction. The testing and/or substantiating data used in this TER is limited to buildings, structures, building elements, construction materials and civil engineering related specifically to buildings.
- 7.3.** The provisions of model, state or local building codes for building construction do not intend to prevent the installation of any material or to prohibit any design or method of construction. Alternatives shall use consensus standards, performance-based design methods or other engineered alternative means of compliance. This TER assesses compliance with defined standards, generally accepted engineering analysis, performance-based design methods, etc. in the context of the pertinent building code requirements.
- 7.4.** Some information contained herein is the result of testing and/or data analysis by other sources, which DrJ relies on to be accurate as it undertakes its engineering analysis.
- 7.5.** DrJ has reviewed and found the data provided by other professional sources are credible. This information has been approved in accordance with DrJ's procedure for acceptance of data from approved sources.
- 7.6.** DrJ's responsibility for data provided by approved sources is in accordance with professional engineering law.
- 7.7.** Where appropriate, DrJ relies on the derivation of design values, which have been codified into law through codes and standards (e.g., *IRC, WFCM, IBC, SDPWS*, etc.). This includes review of code provisions and any related test data that helps with comparative analysis or provides support for equivalency to an intended end-use application.

Technical Evaluation Report (TER)

8. Findings:

- 8.1. When used in accordance with this TER and the manufacturer's installation instructions, the FastenMaster ThruLOK™ Screw Bolt Fastening System meets the requirements for fastening roof headers to columns for the conditions specified in [Table 2](#) and [Table 3](#).
- 8.2. [IBC Section 104.11](#) and [IRC Section R104.11](#) ([IFC Section 104.9](#) is similar) state:

104.11 Alternative materials, design and methods of construction and equipment. The provisions of this code are not intended to prevent the installation of any material or to prohibit any design or method of construction not specifically prescribed by this code, provided that any such alternative has been *approved*. An alternative material, design or method of construction shall be *approved* where the *building official* finds that the proposed design is satisfactory and complies with the intent of the provisions of this code, and that the material, method or work offered is, for the purpose intended, at least the equivalent of that prescribed in this code. ... Where the alternative material, design or method of construction is not *approved*, the *building official* shall respond in writing, stating the reasons the alternative was not *approved*.²
- 8.3. This product has been evaluated with the codes listed in [Section 2](#), and is compliant with all known state and local building codes. Where there are known variations in state or local codes that are applicable to this evaluation, they are listed here:
 - 8.3.1. No known variations
- 8.4. This TER uses professional engineering law, the building code, ANSI/ASTM consensus standards and generally accepted engineering practice as its criteria for all testing and engineering analysis. Dr.J's professional engineering work falls under the jurisdiction of each state Board of Professional Engineers, when signed and sealed.

9. Conditions of Use:

- 9.1. Where required by the authority having jurisdiction (AHJ) in which the project is to be constructed, this TER and the installation instructions shall be submitted at the time of permit application.
- 9.2. Any generally accepted engineering calculations needed to show compliance with this TER shall be submitted to the code official for review and approval.
- 9.3. Design loads shall be determined in accordance with the building code adopted by the jurisdiction in which the project is to be constructed.
- 9.4. The ThruLOK™ Screw Bolt Fastening System covered by this TER shall be subject to the following conditions:
 - 9.4.1. This TER and the installation instructions, when required by a code official, shall be available at the time of permit application.
 - 9.4.2. Installation shall comply with this TER and the manufacturer's installation instructions. In the event of a conflict between this TER and the manufacturer's installation instructions, the more restrictive shall govern.
 - 9.4.3. Fastener designs were evaluated under *NDS* wet service (also known as wet use) conditions to account for the effects of higher header and/or column moisture content.
 - 9.4.4. Lumber used shall be either treated Southern Pine, treated Hem-Fir or treated Douglas Fir.
 - 9.4.5. For conditions not covered in this TER, connections shall be designed in accordance with generally accepted engineering practice.
 - 9.4.6. Manufacturer's installation instructions shall be followed as provided in [Section 6](#) and at fastenmaster.com/details/product/thrulok-screw-bolt-fastening-system.html.
 - 9.4.7. The ThruLOK™ series fasteners are produced by OMG, Inc.'s facility located in Agawam, Massachusetts.
 - 9.4.8. The fasteners are identified by the designation "ThruLOK™" on the packaging. The head of the ThruLOK™ fastener is marked with an "FT" followed by a number corresponding to the length of the fastener.

² The last sentence is adopted language in the 2015 codes.

Technical Evaluation Report (TER)

9.4.8.1. The packaging shall include OMG's name and address, fastener size, third-party inspection agency, and this TER number.

9.4.9. The ThruLOK™ series fasteners are produced under a quality control program subject to periodic inspections in accordance with [IBC Section 1703.5.2](#).

9.5. Design

9.5.1. Building Designer Responsibility

9.5.1.1. Unless the AHJ allows otherwise, the Construction Documents shall be prepared by a Building Designer (e.g., Owner, Registered Design Professional, etc.) for the Building and shall be in accordance with [IRC Section R106](#) and [IBC Section 107](#).

9.5.1.2. The Construction Documents shall be accurate and reliable and shall provide the location, direction and magnitude of all applied loads and shall be in accordance [IRC Section R301](#) and [IBC Section 1603](#).

9.5.2. Construction Documents

9.5.2.1. Construction Documents shall be submitted to the Building Official for approval and shall contain the plans, specifications and details needed for the Building Official to approve such documents.

9.6. Responsibilities

9.6.1. The information contained herein is a product, engineering or building code compliance technical evaluation report performed in accordance with the referenced building codes, testing and/or analysis through the use of accepted engineering procedures, experience and technical judgment.

9.6.2. DrJ technical evaluation reports provide an assessment of only those attributes specifically addressed in the Products Evaluated or Code Compliance Process Evaluated section.

9.6.3. The engineering evaluation was performed on the dates provided in this TER, within DrJ's professional scope of work.

9.6.4. This product is manufactured under a third-party quality control program in accordance with [IRC Section R104.4](#) and [R109.2](#) and [IBC Section 104.4](#) and [110.4](#).

9.6.5. The actual design, suitability and use of this TER for any particular building is the responsibility of the Owner or the Owner's authorized agent, and the TER shall be reviewed for code compliance by the Building Official.

9.6.6. The use of this TER is dependent on the manufacturer's in-plant QC, the ISO/IEC 17020 third-party inspection process, proper installation per the manufacturer's instructions, the Building Official's inspection and any other code requirements that may apply to assure accurate compliance with the applicable building code.

10. Identification:

10.1. Each ThruLOK™ Screw Bolt Fastening System described in this TER is identified by a label on the packaging material bearing the manufacturer's name, product name, label of the third-party inspection agency, and other information to confirm code compliance.

10.2. Additional technical information can be found at fastenmaster.com.

11. Review Schedule:

11.1. This TER is subject to periodic review and revision. For the most recent version of this TER, visit drjengineering.org.

11.2. For information on the current status of this TER, contact [DrJ Engineering](#).



- [Mission and Professional Responsibilities](#)
- [Product Evaluation Policies](#)
- [Product Approval – Building Code, Administrative Law and P.E. Law](#)